



Product Catalogue  
Respiratory & Anaesthesia

# CONTENTS

	PAGE
ABOUT US	1
OXYGEN THERAPY	2
BREATHING SYSTEMS	4 - 7
BREATHING FILTERS AND HMEs	8
ACCESSORIES	9 - 12
PRODUCT IMAGES	13

## ABOUT US

Forca Healthcare is a company that designs and manufactures a wide range of high-quality medical devices. It has a strong commitment towards research and development. The company's core business, namely, innovation and manufacturing of medical devices, is carried out in close collaboration with academia, health care professionals and patients. The process facilitates taking ideas to manufacturable products.

Forca Healthcare understands the changing and challenging clinical environments and needs of customers and their patients. Its goal is to provide the best possible solutions through medical devices developed with attention to detail, user friendliness and simplicity.

This catalogue contains details of a limited range of products specifically designed to assist in the treatment and management of patients requiring respiratory support.

For any further information visit [www.forca-healthcare.com](http://www.forca-healthcare.com).

# OXYGEN THERAPY

An extensive range of products for variable and fixed concentration oxygen therapy. They are made from high quality materials which results in a soft, clear finish for greater patient comfort and easy monitoring of patient condition.

Masks are designed with contours that provide an improved seal. They include adjustable nose clips and elastic braid for better fitting. All tubing included in the range is kink-resistant and fit standard oxygen tubing connectors.

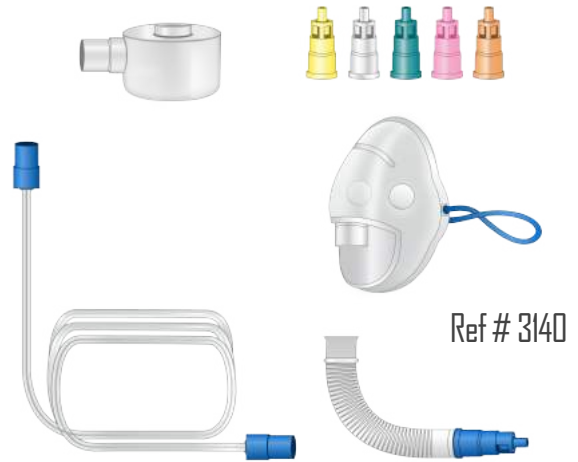

<b>MEDIUM CONCENTRATION OXYGEN MASK (ADULT)</b>	
Mask with nose clip, 2 m oxygen tube	Ref # 3120
<b>HIGH CONCENTRATION OXYGEN MASK (ADULT)</b>	
Mask with nose clip, 0.6 L reservoir bag and 2 m oxygen tube	Ref # 3150
<b>VENTURI MASK KIT (ADULT)</b>	
Mask with nose clip, 6 colour coded venturi valves, 15 cm corrugated tube, humidification cup, 2 m oxygen tube	Ref # 3140
<b>NEBULISER MASK KIT (ADULT)</b>	
Mask, 2 m oxygen tube, nebuliser chamber	Ref # 3180
<b>NEBULISER MASK KIT (PAEDIATRIC)</b>	
Mask, 2 m oxygen tube, nebuliser chamber	Ref # 3190
<b>NASAL CANNULA (ADULT)</b>	
Curved tip prongs, 2 m oxygen tube	Ref # 3160
<b>NASAL CANNULA (PAEDIATRIC)</b>	
Curved tip prongs, 2 m oxygen tube	Ref # 3170
<b>NEBULISER T- KIT (ADULT)</b>	
T mouth piece, 2 m oxygen tube, nebuliser chamber	Ref # 3210

# BREATHING SYSTEMS

A wide variety of breathing systems for anaesthesia or ventilation system. They are designed keeping in mind reliability, convenience and safety.

The breathing systems feature connectors that prevent leaks and disconnections to ensure integrity of the entire anaesthesia or ventilation system. They are also made of bio-compatible and lightweight materials.

## A. STANDARD BREATHING SYSTEM

Breathing systems for passive humidification.

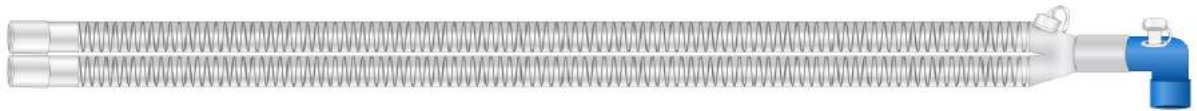

Ref # 1140A/1240

### STANDARD BREATHING SYSTEM (ADULT)

22 mm diameter tube, two limbs, 1.6 m length, Y-piece, 4.3 mm Luer port on elbow, 7.3 mm Luer port on Y-piece

Ref # 1140A

### STANDARD BREATHING SYSTEM (PAEDIATRIC)

15 mm diameter tube, two limbs, 1.6 m length, Y-piece, 4.3 mm Luer port on elbow, 7.3 mm Luer port on Y-piece

Ref # 1240

**B. BREATHING SYSTEMS WITH SINGLE WATER TRAP**

Breathing systems with a single water trap for use with a variety of water bath humidifiers that do not require heated wire breathing systems.



Ref #1120A/1220

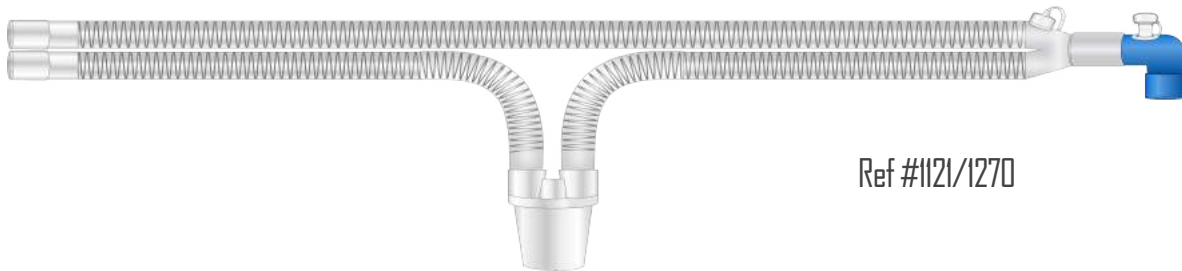

Ref #1121/1270

**BREATHING SYSTEM WITH SINGLE WATER TRAP (ADULT)**

22 mm diameter tube, two limbs, 1.6 m length, one water trap, Y-piece, 4.3 mm Luer port on elbow, 7.3 mm Luer port on Y-piece Ref # 1120A

**BREATHING SYSTEM WITH SINGLE WATER TRAP (PAEDIATRIC)**

15 mm diameter tube, two limbs, 1.6 m length, one water trap, Y-piece, 4.3 mm Luer port on elbow, 7.3 mm Luer port on Y-piece Ref # 1220

**BREATHING SYSTEM WITH SINGLE WATER TRAP + LIMB (ADULT)**

22 mm diameter tube, two limbs, 1.6 m length, one water trap, Y-piece, 4.3 mm Luer port on elbow, 7.3 mm Luer port on Y-piece, 0.8 m limb Ref # 1121

**BREATHING SYSTEM WITH SINGLE WATER TRAP + LIMB (PAEDIATRIC)**

15 mm diameter tube, two limbs, 1.6 m length, one water trap, Y-piece, 4.3 mm Luer port on elbow, 7.3 mm Luer port on Y-piece, 0.8 m limb Ref # 1270

### C. BREATHING SYSTEMS WITH DOUBLE WATER TRAPS

Breathing systems with double water traps for use with a variety of water bath humidifiers that do not require heated wire breathing systems.



Ref #1130A/1230

Ref #1122/1260

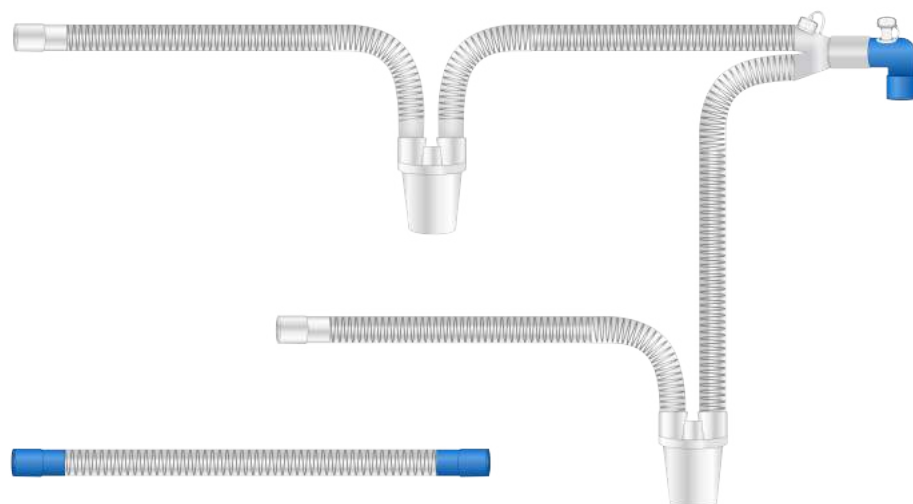

<b>BREATHING SYSTEM WITH DOUBLE WATER TRAPS (ADULT)</b>	
22 mm diameter tube, two limbs, 1.6 m length, two water traps, Y-piece, 4.3 mm Luer port on elbow, 7.3 mm Luer port on Y-piece	Ref # 1130A
<b>BREATHING SYSTEM WITH DOUBLE TRAPS (PAEDIATRIC)</b>	
15 mm diameter tube, two limbs, 1.6 m length, two water traps, Y-piece, 4.3 mm Luer port on elbow, 7.3 mm Luer port on Y-piece	Ref # 1230
<b>BREATHING SYSTEM WITH DOUBLE TRAPS + LIMB (ADULT)</b>	
22 mm diameter tube, two limbs, 1.6 m length, two water traps, Y-piece, 4.3 mm Luer port on elbow, 7.3 mm Luer port on Y-piece, 0.8 m limb	Ref # 1122
<b>BREATHING SYSTEM WITH DOUBLE TRAPS + LIMB (PAEDIATRIC)</b>	
15 mm diameter tube, two limbs, 1.6 m length, two water traps, Y-piece, 4.3 mm Luer port on elbow, 7.3 mm Luer port on Y-piece, 0.8 m limb	Ref # 1260



**D. ANAESTHESIA BREATHING SYSTEMS**

A variety of breathing systems for anaesthesia with various tube types and configurations.

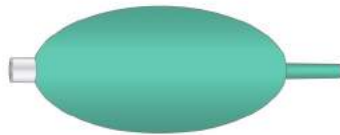

Ref # 1300



Ref # 1310

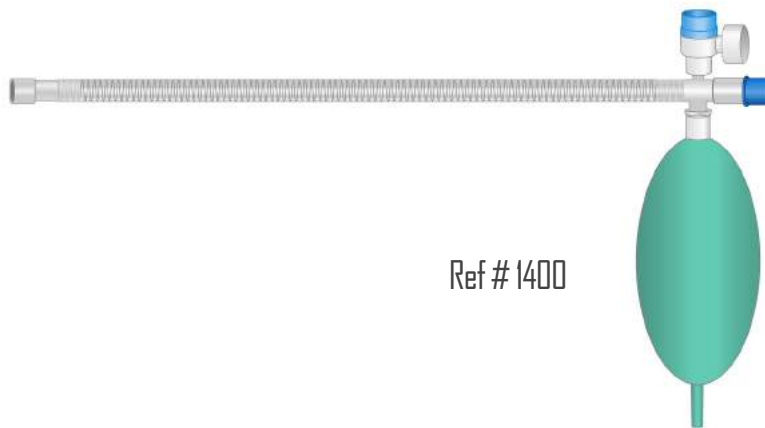

Ref # 1400

**STANDARD BREATHING SYSTEM + LIMB + BREATHING BAG (ADULT)**

22 mm diameter tube, two limbs, 1.6 m length, Y-piece, 4.3 mm Luer port on elbow, 7.3 mm Luer port on Y-piece, 0.8 m limb and 2L breathing bag

Ref # 1300

**DUO LIMBO BREATHING SYSTEM (ADULT)**

22 mm diameter bi lumen tube, one limb, 1.5 m length, 4.3 mm Luer port on elbow, 0.5 m limb

Ref # 1310

**MAPELSON D (BAIN) COAXIAL BREATHING SYSTEM (ADULT)**

30 mm diameter tube, one coaxial limb, 1.6m length, 4.3 mm Luer port on elbow, 2L breathing bag, APL valve

Ref # 1400

# BREATHING FILTERS AND HMEs

A range of breathing filters, heat and moisture exchangers (HME) and combined products for patient protection and humidification designed for use in anaesthesia and intensive care.

Ref # 2140/2240



Ref # 2120/2220

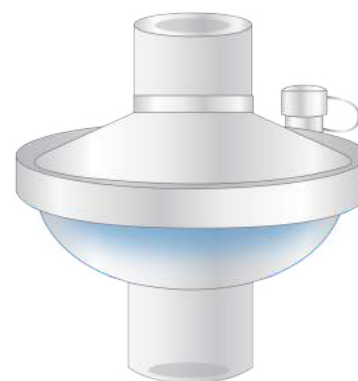

Ref # 2130/2230

## BACTERIAL VIRAL FILTER (ADULT)

Luer-lock sampling port, 22F-22M/15F connections

Ref # 2120

## BACTERIAL VIRAL FILTER (PAEDIATRIC)

Luer-lock sampling port, 15F/22M, 15M connections

Ref # 2220

## HEAT AND MOISTURE EXCHANGER (ADULT)

Luer-lock sampling port, 22F-22M/15F connections

Ref # 2140

## HEAT AND MOISTURE EXCHANGER (PAEDIATRIC)

Luer-lock sampling port, 15F/22M, 15M connections

Ref # 2240

## BACTERIAL VIRAL FILTER WITH HME (ADULT)

Luer-lock sampling port, 22F-22M/15F connections

Ref # 2130

## BACTERIAL VIRAL FILTER WITH HME (PAEDIATRIC)

Luer-lock sampling port, 15F/22M, 15M connections

Ref # 2230

## FLEXIBLE CATHETER MOUNTS

Flexible catheter mounts with a variety of elbow connections and ports for all applications. Available with or without Luer ports for secure attachment of gas sampling lines. All port caps are retainable for safety and fixed to the port connectors to ensure they cannot be misplaced in use.

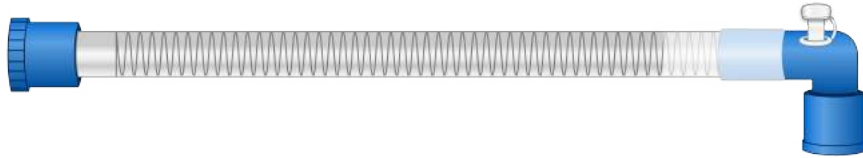

Ref # 4140/4120/4130

### FLEXIBLE FIXED ELBOW CATHETER MOUNT

22F-22M/15F connections, 150 mm length tube	Ref # 4140
22F-22M/15F connections, 150 mm length tube, 4.3 mm Luer port	Ref # 4120
22F-22M/15F connections, 150 mm length tube, 7.6 mm Luer port	Ref # 4130

## SUCTION

The suction set can be used for removal of fluids through a connection with an external source of suction. They include ergonomic transparent handles offers a firm grip along with kink resistant transparent tubing which makes draining visible.

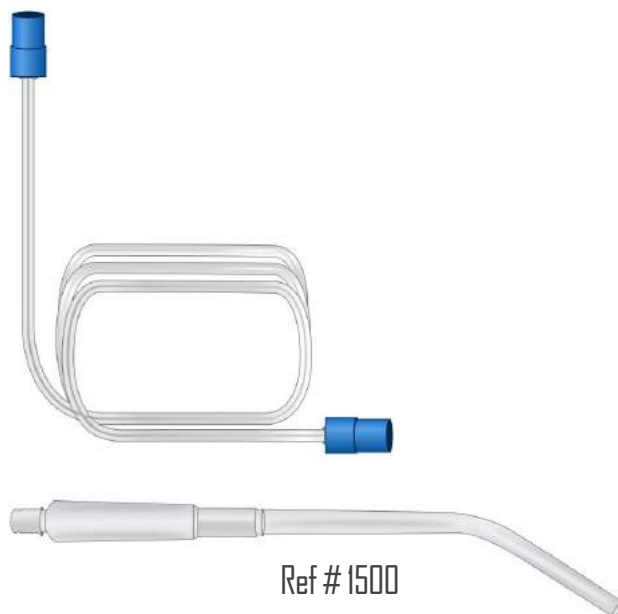

Ref # 1500

### YANKAUER SUCTION SET

Sterile suction Yankauer with straight tip, 2 m tube

Ref # 1500

# MONITORING LINES

Pressure monitoring lines to observe the pressure to create a connection between the syringe infusion pump and the patient and to extend medical tubing. Various configurations of tube lengths and connectors are available. All tubing is kink resistant.

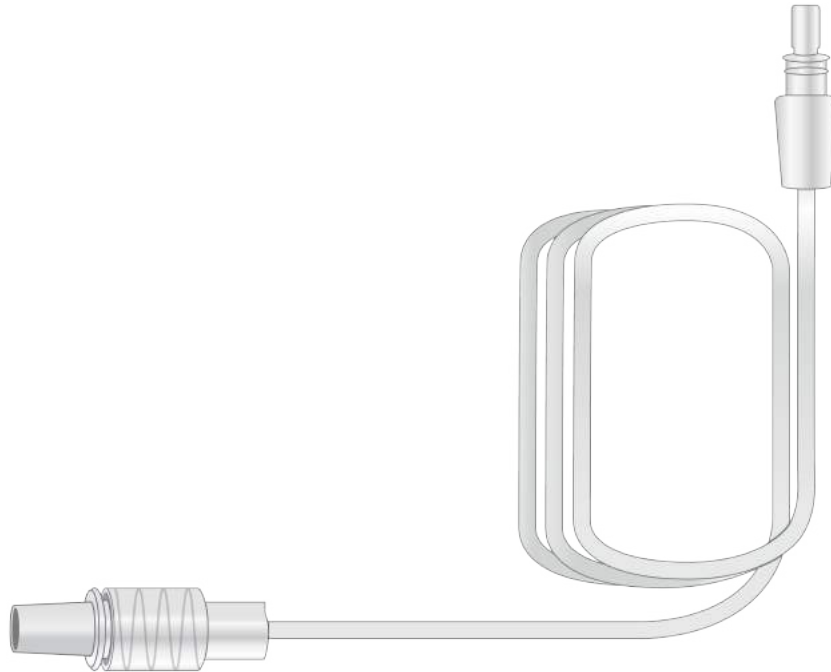

## PRESSURE MONITORING LINE (MALE/FEMALE CONNECTORS)

10 cm	Ref # 1610B
15 cm	Ref # 1611B
30 cm	Ref # 1612B
50 cm	Ref # 1613B
100 cm	Ref # 1614B
150 cm	Ref # 1615B
200 cm	Ref # 1616B

## PRESSURE MONITORING LINE (MALE/MALE CONNECTORS)

10 cm	Ref # 1610C
15 cm	Ref # 1611C
30 cm	Ref # 1612C
50 cm	Ref # 1613C
100 cm	Ref # 1614C
150 cm	Ref # 1615C
200 cm	Ref # 1616C

## 3-WAY STOPCOCK WITH EXTENSION LINES

3-way stopcock with extension lines for use with infusion or transfusion apparatus. They also provide an alternative channel for the introduction of medication to the patient. The extension lines are made with high quality kink resistant tube that has smooth inner surfaces ensures smooth fluid movement. Fitted with a three arm handle allows for smooth movement to change fluid direction for facilitating smooth and easy operations arrow mark indicating direction of flow.



### 3-WAY STOPCOCK WITH EXTENSION LINE

7 cm extension line	Ref # 1901
10 cm extension line	Ref # 1902
15 cm extension line	Ref # 1903
25 cm extension line	Ref # 1904
50 cm extension line	Ref # 1905
100 cm extension line	Ref # 1906
150 cm extension line	Ref # 1907
200 cm extension line	Ref # 1908

# RESUSCITATION KITS

Manual resuscitation kits are used in resuscitation and emergency care to allow immediate respiratory support to the patient without compromising the safety of the rescuer.

Mouth to Mask Resuscitators have an aerosol tubing, one-way duck-bill valve and exhalation flow diverter which protects rescue worker from direct contact with patient and patient exhalation. Bags have housing which allows for visualization of patient valve. Bag design and texture facilitates grip and manageability.

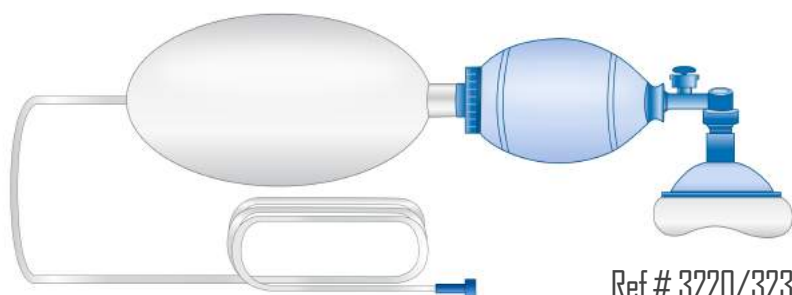

## RESUSCITATION KIT (ADULT)

Mask, 2 m oxygen tube, 2000 ml reservoir bag, self inflating bag, pressure relief valve

Ref # 3220

## RESUSCITATION KIT (PAEDIATRIC)

Mask, 2 m oxygen tube, 1600 ml reservoir bag, self inflating bag, pressure relief valve

Ref # 3230

# PRODUCT IMAGES

## OXYGEN THERAPY



## BREATHING SYSTEMS

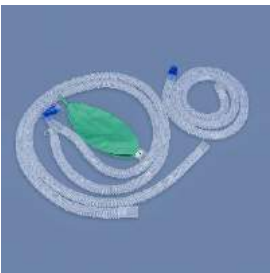

## BREATHING FILTERS & HMEs



## SUCTION



## 3-WAY STOPCOCK WITH EXTENSION LINE



## FLEXIBLE CATHETER MOUNT



## MONITORING LINES





**LOCATIONS**

 Bangalore, India  
Ajman, United Arab Emirates

**PHONE**

 +91 9980 968 402

**E-MAIL**

 [info@forca-healthcare.com](mailto:info@forca-healthcare.com)

**WEB**

 [www.forca-healthcare.com](http://www.forca-healthcare.com)